



● Thank you for purchasing KOSO GPS Lap Timer. Before operating this unit, please read the instruction thoroughly and retain them for future reference.

⚠ Notice

- This product only functions with DC 12 V.
- Any damages caused by faulty installation shall be imputed to the users.
- To avoid a short circuit from occurring, do not pull or modify the wires during installation.
- Disassembling the instrument will void any warranty. Maintenance and repairs should be executed by our professionals only.

⊙ About GPS

- Global Positioning System, GPS is a system that developed and managed by the United States Department of Defense. The system consists of 24 GPS satellites. Only 3 of which are needed in order to provide accurate positioning, speed detection and high precision time for most locations. The more satellites received, the more accurate each location will be decoded.
- Positioning accuracy control and system functions: due to policy consideration and national security, the U.S. reserves the right to control the systems functions and positioning accuracy without advanced notice or any notification at all. Weather conditions, as well as, environment and terrain will affect normal reception of satellite signal.
- Satellite signal cannot be received in the following environmental and terrain conditions: at the bottom of hills, tunnels, underpasses, between high buildings and in dense forests.

● MARK SYMBOL:

⚠ Some procedures must be followed in order to avoid faulty installation.

⚠ **WARNING!** Some procedures must be followed in order to avoid damages from occurring to yourself and others.

⚠ **CAUTION!** Some procedures must be followed in order to avoid damages from occurring to the vehicle.

1-1 Accessories

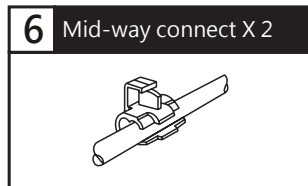
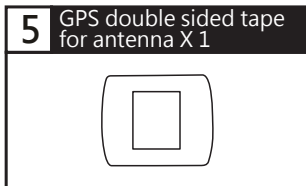
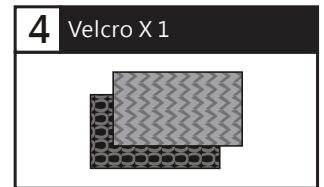
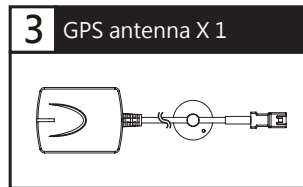
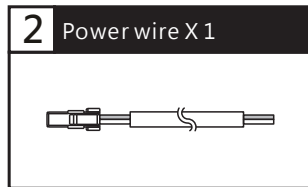

NOTE Contact your local distributor if the items you received are not the same as the items listed above.

1-2 Optional accessories

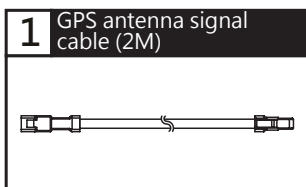

NOTE For more information on the optional accessories, contact your local distributor.

2 Wiring installation instructions

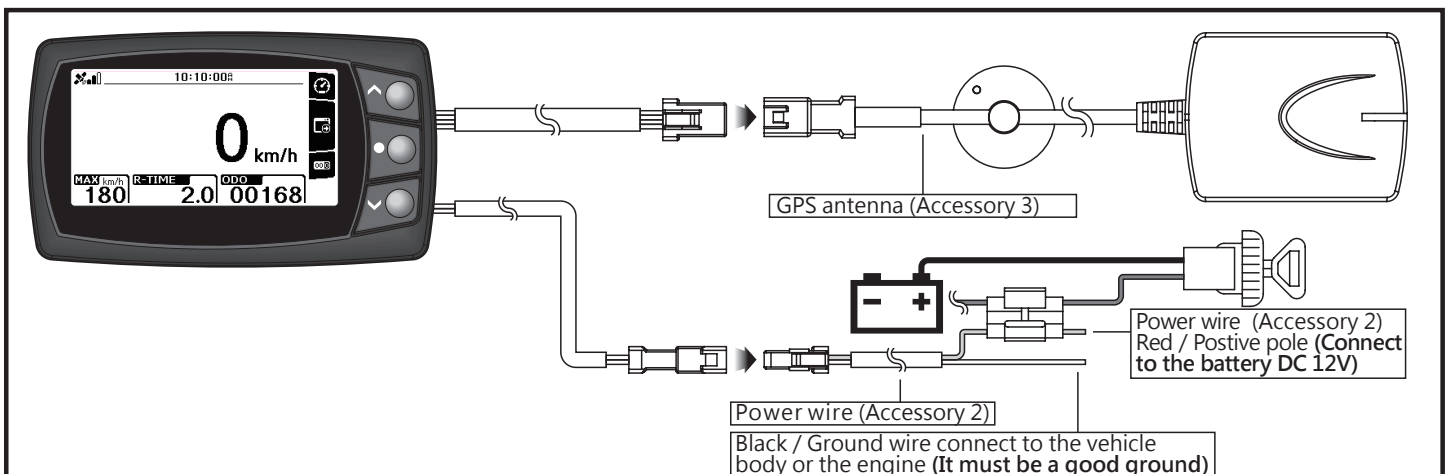

⚠ Do not install the GPS antenna inside the vehicle, because windshield heat isolation film will result in poor signal reception. It is recommended to be installed on top of the vehicle.

⚠ GPS antenna should not be in contact with cell phones and transceivers, because that could cause signal reception problems.

3-1 Overview

Clock

- Setting range : 12、24 H
- Automatically set clock according to time zone selected.

GPS message display area

AVE Speed

- Record range : 0 ~ 360 km/h (0 ~ 255 MPH)
- Record unit : 1 km/h (MPH)

Top speed record (Max.)

- Record range : 0 ~ 360 km/h (0 ~ 255 MPH)
- Record unit : 1 km/h (MPH)

Riding time

- Record range:0 ~ 9,999.9 H · reset automatically after 9,999.9 H
- Record unit:0.1 H

Key symbol display area

Speedometer

- Display range:0~360 km/h (0~255 MPH)
- Display range:1 km/h (MPH)

Odo meter

- Display range : 0 ~ 99,999 km (mile) · reset automatically after 99,999 km (mile)
- Display unit : 1 km (mile)

Trip meter

- Display range : 0 ~ 9,999.9 km (mile) · reset automatically after 9,999.9 km (mile)
- Setting unit : 0.1 km (mile)

3-2 Function settings instructions

● Speedometer	Display range : 0~360 km/h (0 ~ 255 MPH) Display range : 1 km/h (MPH)	● Timing mode	
○ Display internal	<0.5 second	○ Single recording time	Record range : 00'00"00~99'59"99
○ Odometer	Display range : 0 ~ 99,999 km (mile) · reset automatically after 99,999 km (mile) Display range : 1 km/h (MPH)	○ Number of loop record	Record range : 1~200 Laps (Maximum)
○ Trip meter	Display range : 0 ~ 9,999.9 km (mile) · reset automatically after 9,999.9 km (mile) (delete average speed and run time records simultaneously)(delete average speed and run time records simultaneously) Display range : 0.1 km/h (MPH)	○ Time difference compares to the best time record	Display range : 00'00"~99'99"
○ AVE Speed	Record range : 0~360 km/h (0~255 MPH) Record unit : 1 km/h (MPH)	○ Time difference compares to last loop	Display range : -99'99"~+99'99"
○ Riding time	Record range : 0 ~ 9,999.9 H · reset automatically after 9,999.9 H Record unit : 0.1 H	○ Record display method	Setting range : Sequentially、Best
○ Top speed record	Record range : 0~360 km/h (0~255 MPH) Record unit : 1 km/h (MPH)	○ Record displays retention time	Setting range : 5~20 second
● Geodetic coordinate system WGS-84		● Target speed timer	Setting range : 30 ~ 360 km/h (20~255 MPH) Setting unit : 5 km/h (MPH)
○ Coordinate display method	Setting range : d°m's.s" · d.d° · d°m.m'	● Target distance timer	Setting range : 1/32~30/32 mile (50~1,500 M) Setting unit : 1/32 mile (50 M)
● Time zone	Setting range : UTC -12:00 ~ +14:00	○ Closed track single loop time recording	Setting range : 0'00"00 ~ 9'59"99
● Calendar	Automatic Time Adjustment by GPS signal	○ Open track single loop time recording	Setting range : 0'00"00 ~ 9'59"99
● Clock	Setting range : 12、24 H Automatically set clock according to time zone selected.	● Create track	Setting range : close, open
● Voltage warning	Battery symbol flashes when voltage is lower than the 7.0 V	○ Track width	Setting range : 5 ~ 50 M Setting unit : 1 M
● Display contrast adjustment	Setting range:1~16 level	○ Track length	Auto-calculation after travel a loop
● Backlight brightness adjust	Setting range : 0(Close) · 1(Darkest)~7 (Brightest). The backlight brightness will change immediately after you set the value.	○ Checkpoint	Checkpoint Setting range : 0 ~ 22points (Max)
		● Effective voltage	DC 12 V
		● Effective temperature range	-10 ~ +60 °C
		● Meter standard	JIS D 0203 S2
		● Meter size	107.7 X 61.7 X 20.5 mm
		● Meter weight	132.2 g

3-3 Key symbol descriptions

Boot screen	Race Display			Settings Display
MAX / AVE	Scores	OK	New	Select
Next tab	Race	Return	Checkpoint	Edit / Add
ODO / Trip	Select	Return	View	Edit / Sub
	Open	Abort	Edit	Delete
	Start	Abort	Up	
	Go	Exit	Down	
	Finish	Exit		

4 Entering settings and functions index menu

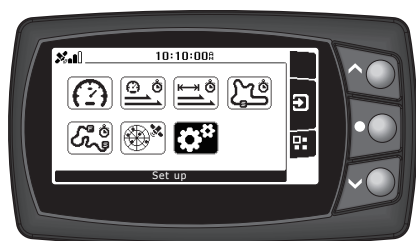

- In the main screen settings hold the button ● to enter into the settings menu.
- Function index
 - └ a 1. Unit
 - └ a 2. Racing
 - └ a 3. Display (Contrast / Brightness)
 - └ a 4. Memory
 - └ a 5. Info
- Exit settings

5 Startup positioning

There are two scenarios for Startup Positioning Time.

Status	Time
● Used the Lap Timer very frequently.	● Around 1- 45 seconds.
● Haven't used the Lap timer for over 14 days. ● You are using the lap timer with 100km+ away from your last turn off position then it will take longer to start up for positioning.	● Around 2 - 5 minutes.

⚠ CAUTION! The following situations are classified as normal:

- When the receiving environment is bad or the GPS positioning is just finished, the meter may display speed when the vehicle is stationary.
- The actual mileage and the displayed mileage in the meter (ODO / Trip) might have 1% - 5% accumulated difference depending on the average satellite signal strength and user habits.

6 Trouble shooting

The following situation does not indicate malfunction of the meter. Please check the following before taking it in for repairs.

Trouble	Check item	Trouble	Check item
The meter doesn't work when the power is on.	<ul style="list-style-type: none"> ● The power doesn't supply to the meter. → Please make sure the wiring is connected. The wiring and fuse are not broken. → The battery is broken or the battery is too old to supply enough power (DC 12 V) to make the meter for it to work. 	Speed does not appear or appears incorrectly.	<ul style="list-style-type: none"> ● Improper connection of GPS antenna. → Make sure the GPS antenna is connected correctly and no wires are broken. ● GPS antenna error → Make sure the GPS antenna test light is flashing normally. → Normal flashing frequency is 60 times per minute.
The meter shows the wrong readings	<ul style="list-style-type: none"> ● Check the voltage of your battery, and make sure the voltage is over DC 12 V. 	Temp does not appear or appears incorrectly	<ul style="list-style-type: none"> ● Incorrect time zone settings → Check unit operation settings in section 4.1

※ If the problems persist after reviewing the above information, please contact your local distributors or us.

