



MSS.05.296.10001/B  
Revision: 01

## Motorschutz SUZUKI DL 650 V-Strom Engine Guard SUZUKI DL 650 V-Strom

### Montagehinweise

Alle vom Motorrad gelösten Schrauben sind gemäß Herstellerangaben wieder zu montieren, oder mit von SW-MOTECH gelieferten Schrauben zu ersetzen. Falls nicht anderweitig definiert, diese Schrauben nach Tabelle anziehen:

<b>M6</b>	<b>9,6 Nm</b>
<b>M8</b>	<b>23 Nm</b>
<b>M12</b>	<b>79 Nm</b>

Gegebenenfalls Schrauben mit flüssiger Schraubensicherung einkleben.

Prüfen Sie nach 50 km alle Verbindungen auf festen Sitz.

SW-MOTECH GmbH & Co. KG  
Ernteweg 8/10  
35282 Rauschenberg  
Germany

Tel. +49 (0) 64 25/8 16 8-00  
Fax +49 (0) 64 25/8 16 8-10

info@sw-motech.com  
www.sw-motech.com

### Mounting Instruction

SW-MOTECH products should be installed by a qualified, experienced motorcycle technician. If you are unsure of your ability to properly install a product, please have the product installed by your local motorcycle dealer. SW-MOTECH takes no responsibility for damages caused by improper installation.

All screws, bolts and nuts, including all replacement hardware provided by SW-MOTECH, should be tightened to the torque specified in the OEM maintenance manual for your motorcycle. If no torque specifications are provided in the OEM maintenance manual, the following torques may be used:

<b>M6</b>	<b>9,6 Nm</b>
<b>M8</b>	<b>23 Nm</b>
<b>M12</b>	<b>79 Nm</b>

All screws, bolts and nuts should be checked after driving the first 50 km to ensure that all are tightened to the proper torque.

Medium strength liquid thread-locker (i.e., "Loctite") should be used to secure all screws, bolts and nuts.

INFORMATION

Achtung: Die Kurven- und Bodenfreiheit kann durch einen Motorschutz eingeschränkt werden.

Attention: Cornering and ground clearance can be reduced by using an engine guard.

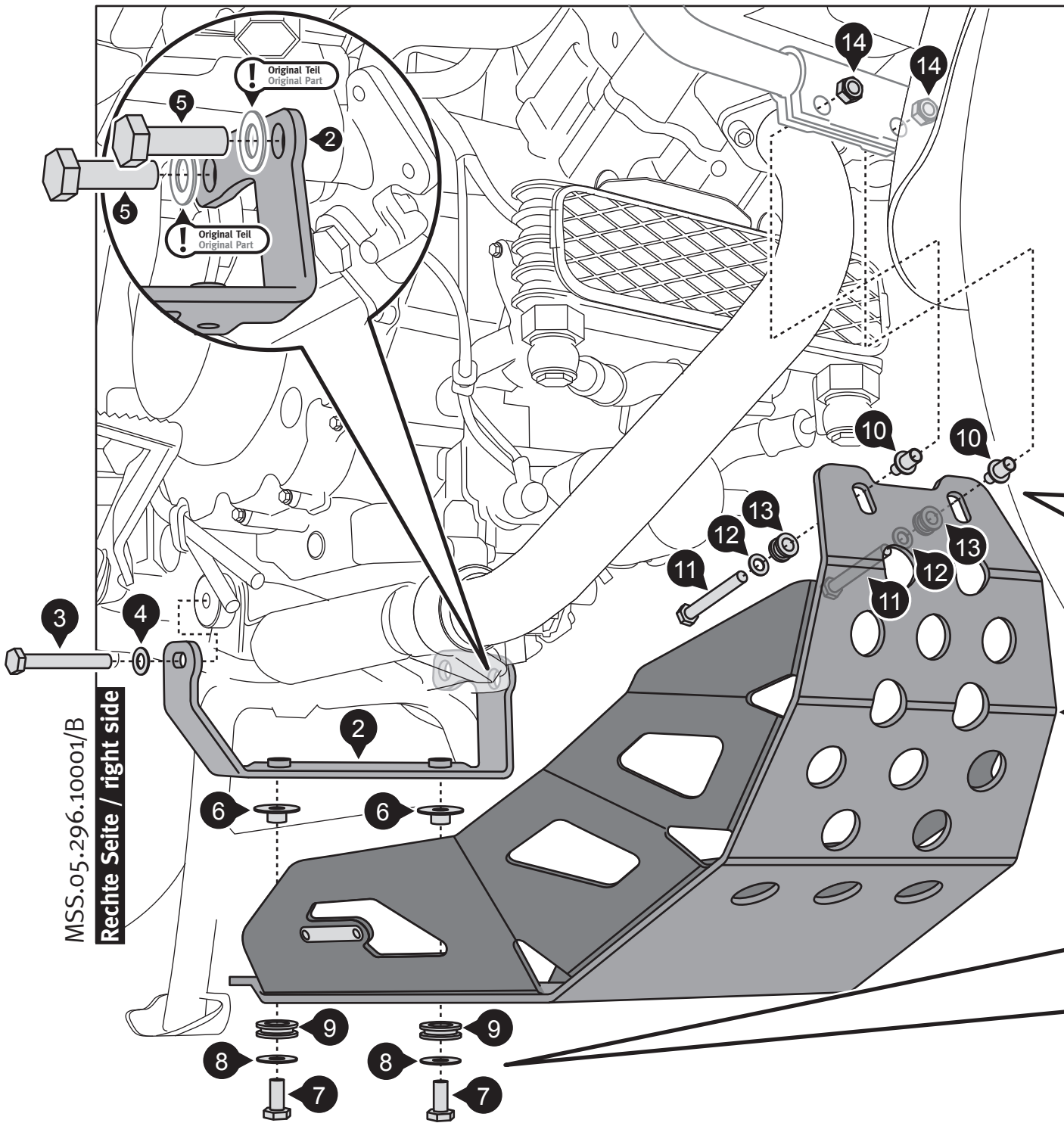

**INFORMATION**

Achtung: Die Montage dieses Motorschutz ist nur in Verbindung mit dem SW-MOTECH Schutzbügel (Art.-Nr.: SBL.05.295.100 bzw. SBL.05.674.10000/B) sowie dem SUZUKI OEM Schutzbügel möglich.

Attention: The SW-MOTECH crashbar (No.: SBL.05.295.100 and SBL.05.674.10000/B) or SUZUKI OEM crashbar is required for mounting this engine guard on the bike.

**INFORMATION**

Justieren Sie den Motorschutz vor dem Anziehen aller Schraubverbindungen über die Langlöcher in Fahrtrichtung, um ausreichend Abstand zwischen Motorschutz und Auspuff zu gewährleisten.

Adjust the engine guard with the ablong holes (in driving direction) to have enough space between the exhaust and engine guard.

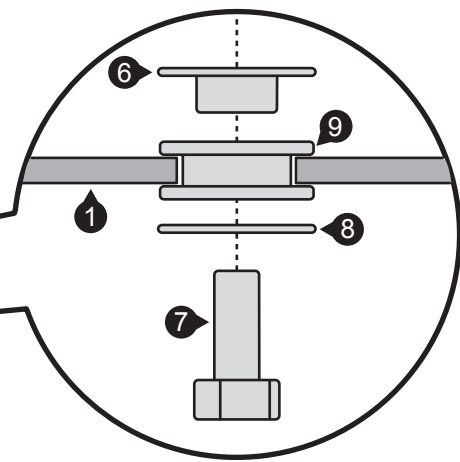
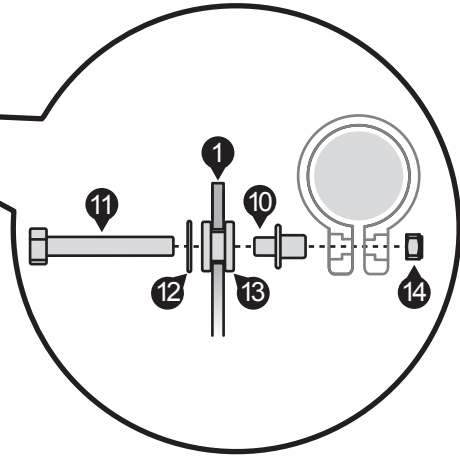

1 Motorschutz  
Engine Guard



MSS.05.296.910 01

Anzahl/ Pcs. 1

2 Anbautraverse  
Mounting Bracket



MSS.05.296.013 03

Anzahl/ Pcs. 1

6 Bundbuchse  
Flanged Spacer



MSS.05.296.006 00

Anzahl/ Pcs. 2

10 Bundbuchse  
Flanged Spacer



MSS.05.296.004 00

Anzahl/ Pcs. 2

14 Mutter, selbstsichernd  
Lock Nut



M6 DIN 985

Anzahl/ Pcs. 2

3 Sechskantschraube  
Hexagon Screw



M8 x 50 DIN 931

Anzahl/ Pcs. 1

5 Sechskantschraube  
Hexagon Screw



M12 x 1,25 x 35 DIN 961

Anzahl/ Pcs. 2

7 Sechskantschraube  
Hexagon Screw



M8 x 25 DIN 933

Anzahl/ Pcs. 2

11 Sechskantschraube  
Hexagon Screw



M6 x 40 DIN 931

Anzahl/ Pcs. 2

4 Unterlegscheibe  
Washer



A 8,4 DIN 125

Anzahl/ Pcs. 1

8 Unterlegscheibe  
Washer



A 8,4 DIN 9021

Anzahl/ Pcs. 2

12 Unterlegscheibe  
Washer



A 6,4 DIN 9021

Anzahl/ Pcs. 2

9 Gummitülle  
Rubber Element



GT.00.12H3488

Anzahl/ Pcs. 2

13 Gummitülle  
Rubber Element



GT.00.12H3472

Anzahl/ Pcs. 2