

TRIUMPH TIGER 900 GT / GT LOW / GT PRO / RALLY / RALLY PRO '20-

M O U N T I N G I N S T R U C T I O N S











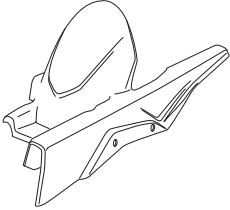
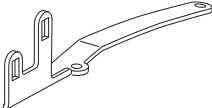

REF 20379

REAR MUDGUARD / GUARDABARROS TRASERO



ALLEN
Nº 3
Nº 4
Nº 5



ID	PIEZA/PART	DESCRIPCIÓN	DESCRIPTION	QTY	REF
1		Guardabarros	Mudguard	1	20379J/CM3
2		Soporte	Support	1	SOPORIP2--20379
3		Tuerca enjaulada de aluminio M6 (se suministra montada)	Lock nut M6 (supplied mounted)	2	TUERCAJFM6--716
4		Tornillo Allen M6x25 Ø14 ISO7380	M6x25 Ø14 ISO7380 Allen screw	1	TORNI-I7380-405
5		Tornillo Allen M6x20 Ø14 ISO7380	M6x20 Ø14 ISO7380 Allen screw	3	TORNI-I7380-404
6		Tornillo especial M6x12 Long Hexagonal 34 (rosca int M5x15)	M6x12 special screw Hexagonal lenght 34 (rosca int M5x15)	1	TORNI-E-----762
7		Tornillo Allen M5x16 Ø11 ISO 7380	M5x16 Ø11 ISO 7380 Allen screw	1	TORNI-I7380-493
8		Tapón tornillo M5	M5 screw cap	1	TAPON-----85
9		Tapón tornillo M6	M6 screw cap	4	TAPON-----86
10		Silentblock Ø18x Ø9 xØ11 x8	Ø18x Ø9 xØ11 x8 silentblock	5	SILENBGONE--064
11		Casquillo con valona Ø15 xØ9 x7,5	Ø15 xØ9 x7,5 bush with flange	5	CASQUI-1A---324
12		Casquillo Ø14x Ø8,5 X9	Ø14x Ø8,5 X9 arrowhead	1	CASQUI-----777
13		Casquillo Ø14x Ø8,5 x12	Ø14x Ø8,5 x12 arrowhead	1	CASQUI-M---769
14		Tornillo M6x15 DIN912	M6x15 DIN912 screw	2	TORNI-AD912-430

TRIUMPH TIGER 900 GT / GT LOW / GT PRO / RALLY / RALLY PRO '20-

INSTRUCCIONES DE MONTAJE - MOUNTING INSTRUCTIONS - MONTAGEANLEITUNG

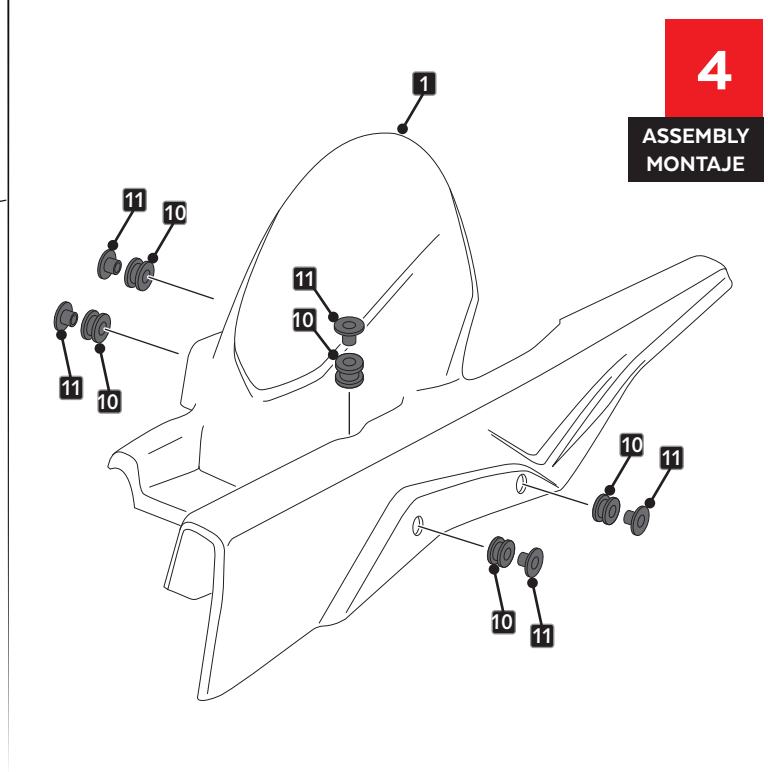
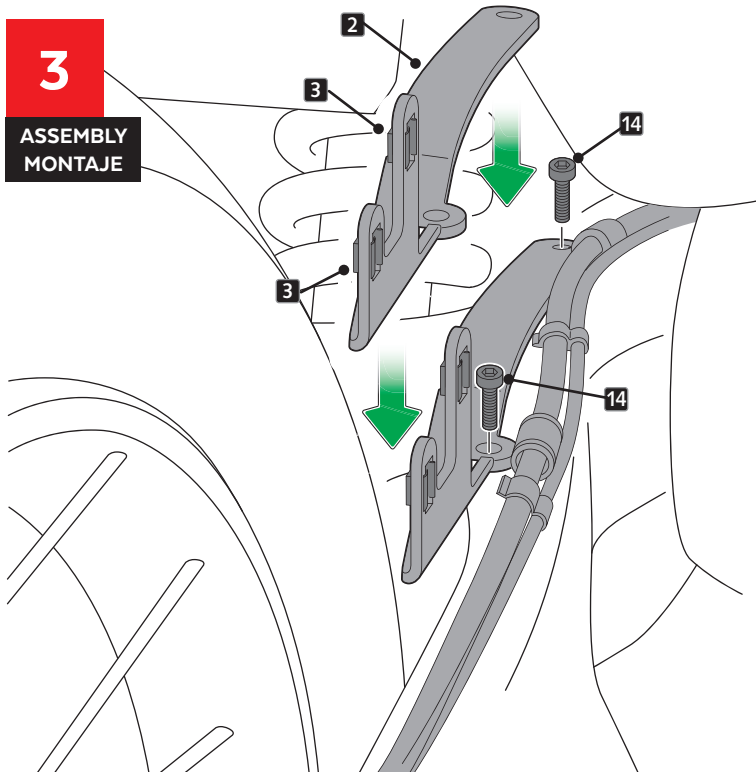
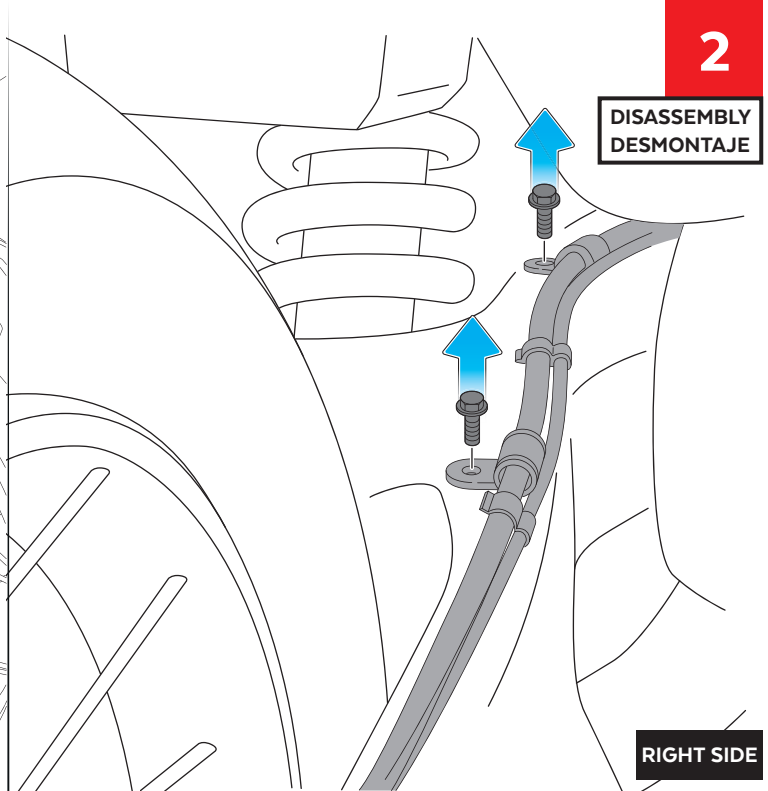
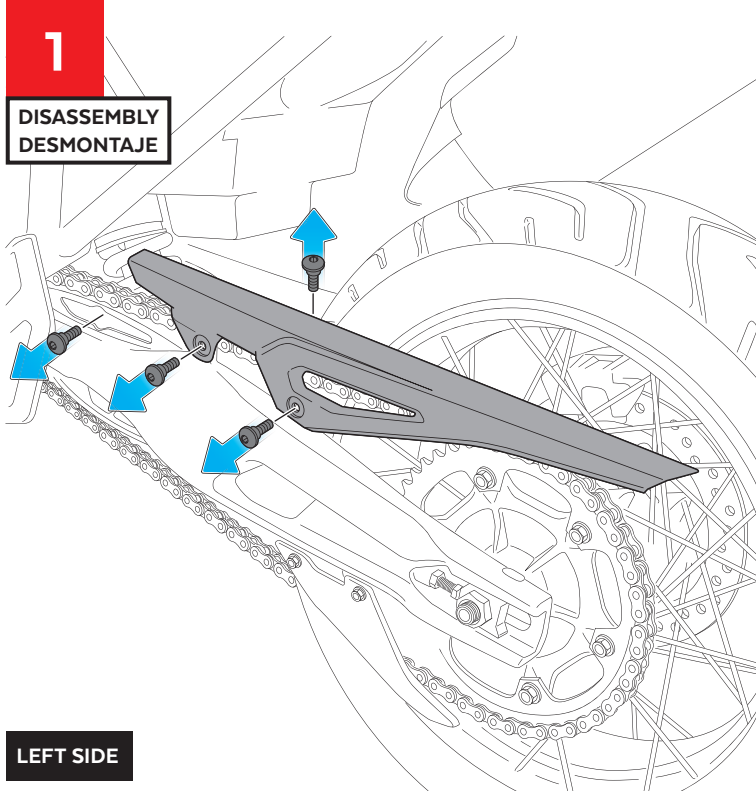

TRIUMPH TIGER 900 GT / GT LOW / GT PRO / RALLY / RALLY PRO '20-

INSTRUCCIONES DE MONTAJE - MOUNTING INSTRUCTIONS - MONTAGEANLEITUNG

5

ASSEMBLY
MONTAJE

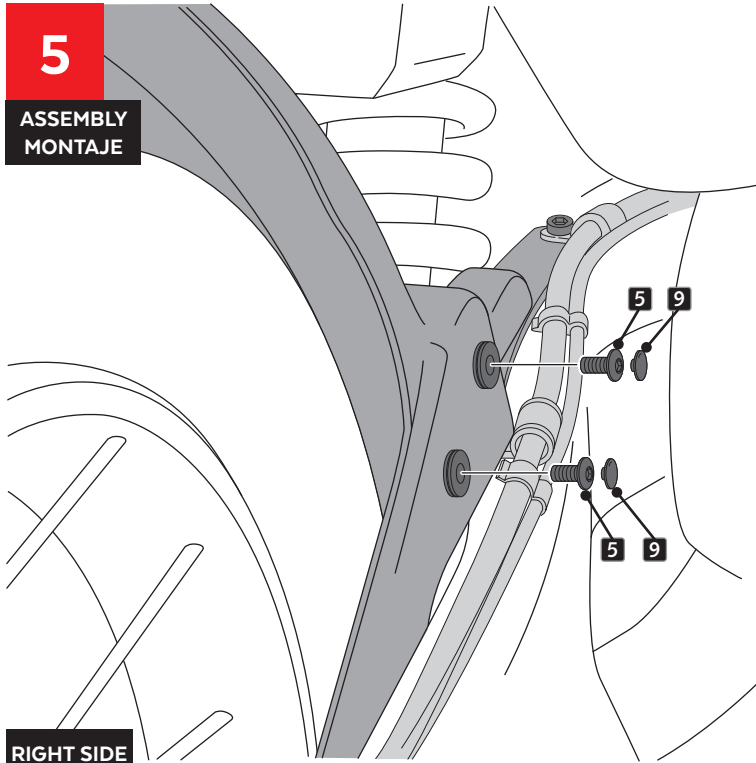

RIGHT SIDE

6

ASSEMBLY
MONTAJE

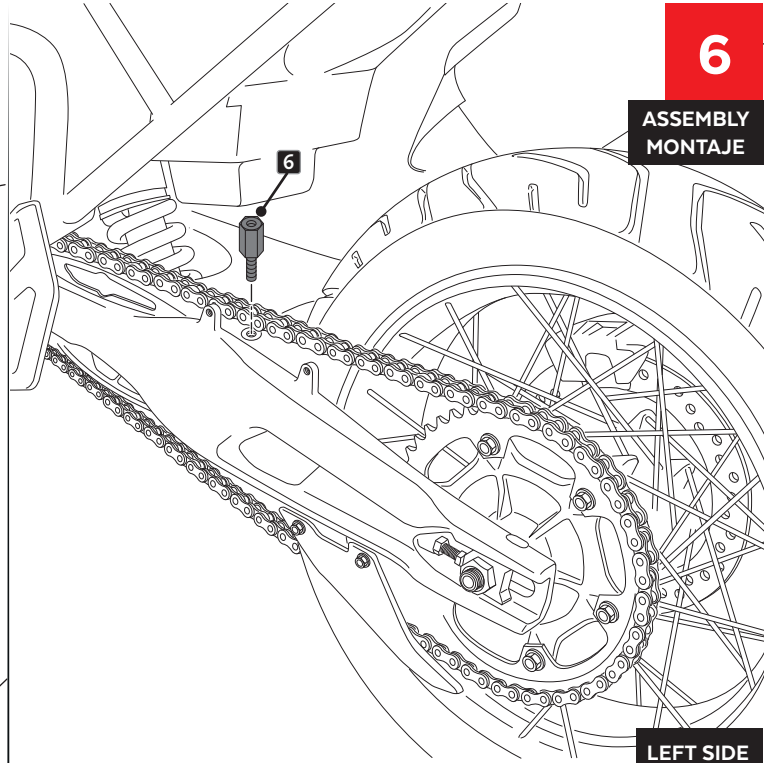

LEFT SIDE

7

ASSEMBLY
MONTAJE

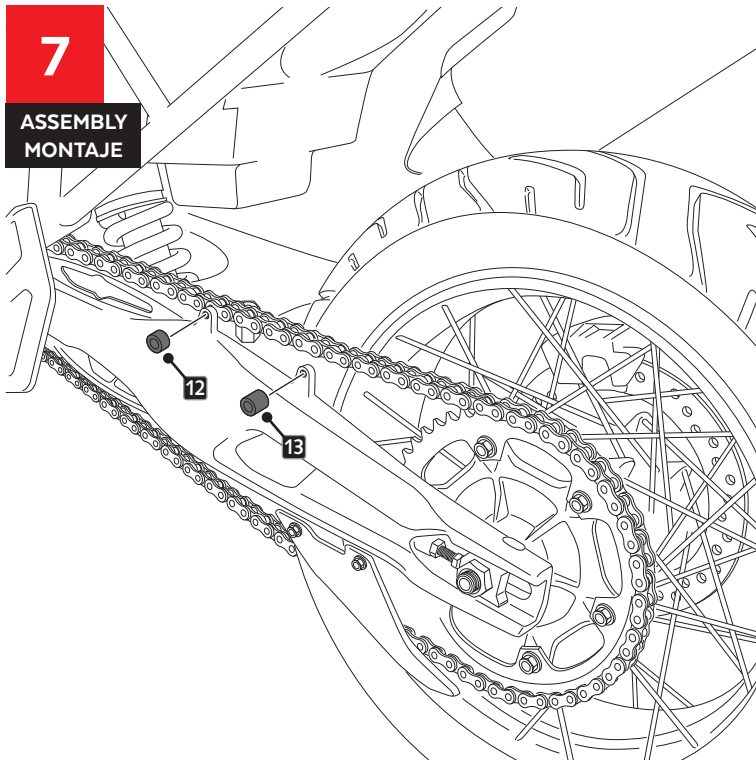

8

ASSEMBLY
MONTAJE

