

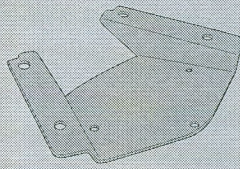











SR3104 - KR3104

PORTAPACCO SPECIFICO - SPECIFIC HOLDER - PORTE-PAQUET SPÉCIFIQUE - SPEZIFISCHER TRÄGER - PORTA-EQUIPAJE ESPECÍFICO - TRANSPORTADOR ESPECÍFICO

SUZUKI BURGMAN 650 (2013)

N°	Descrizione	Caratteristiche	Codice	Quantità	
1	Supporto - Support - Support Halterung - Soporte - Apoio	Sp. 4mm	GL709	1	
2	Piastra - Plate Platine - Platte Parrilla - Grelha	-	Z622M	1	
3	Vite - Screw Vis - Schraube Tornillo - Parafuso	TEF M8x70	870TEF	1	
4	Vite - Screw Vis - Schraube Tornillo - Parafuso	TEF M8x55	855TEF	2	
5	Vite - Screw Vis - Schraube Tornillo - Parafuso	TCEI M6x25	625TCE	4	
6	Distanziale - Spacer Entretoise - Distanzstueck Distanciador - Espaçador	Ø16x50 Foro 8,5mm	V502	1	
7	Distanziale - Spacer Entretoise - Distanzstueck Distanciador - Espaçador	Ø16x40 Foro 8,5mm	V503	2	
8	Rondella - Washer Rondelle - Scheibe Arandela - Arruela	Ø6	6RON	4	
9	Rondella - Washer Rondelle - Scheibe Arandela - Arruela	Ø6x18	618RON	4	
10	Dado - Bolt - Ecrou Mutter - Tuerca - Porca	Auto Bloccante M6	6DADIAU	4	
11	Copriforo - Bolt Cap Cache Trou - Stoplock Tapa Agujero - Tampa do Orifício	-	Z621	6	
12	Protezione Adesiva - Adhesive Protection Protection Adhesive - Schutzkleber Protección Adhesiva - Proteção Adesiva	Ø32x3 Foro15mm	Z1072	3	

SR3104 - KR3104

PORTAPACCO SPECIFICO - SPECIFIC HOLDER - PORTE-PAQUET SPÉCIFIQUE - SPEZIFISCHER TRÄGER - PORTA-EQUIPAJE ESPECÍFICO - TRANSPORTADOR ESPECÍFICO

SUZUKI BURGMAN 650 (2013)

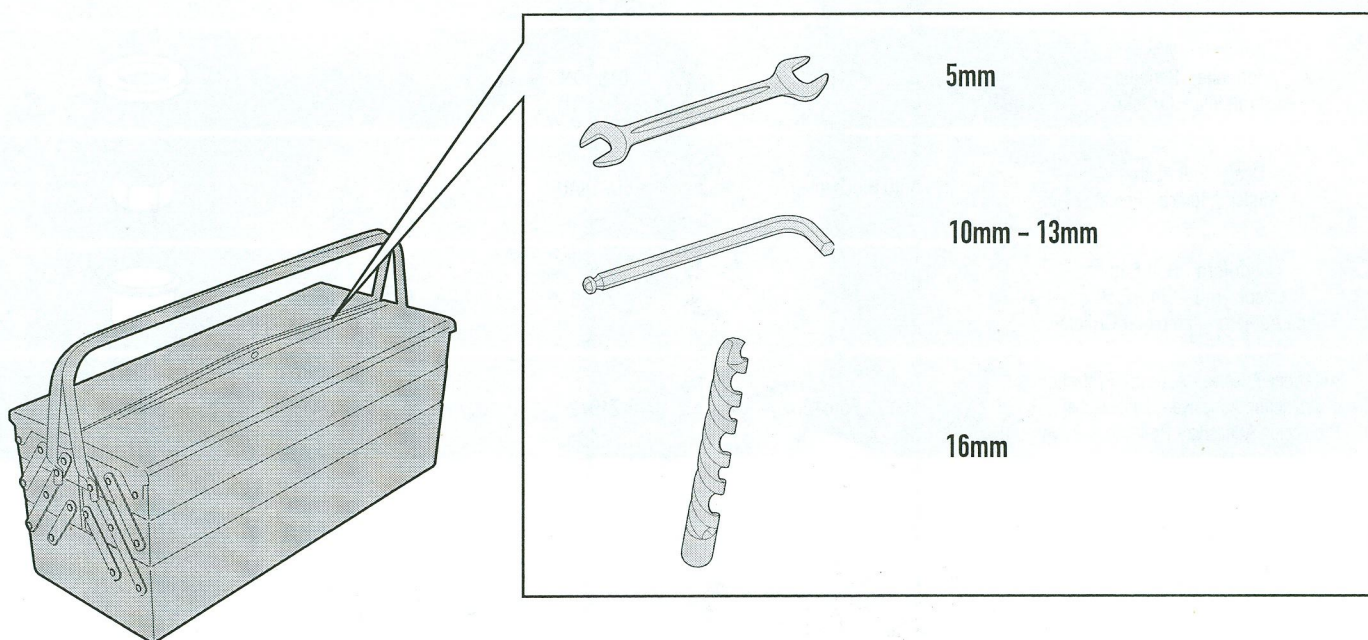

SR3104 - KR3104

PORTAPACCO SPECIFICO - SPECIFIC HOLDER - PORTE-PAQUET SPÉCIFIQUE - SPEZIFISCHER TRÄGER - PORTA-EQUIPAJE ESPECÍFICO - TRANSPORTADOR ESPECÍFICO

SUZUKI BURGMAN 650 (2013)

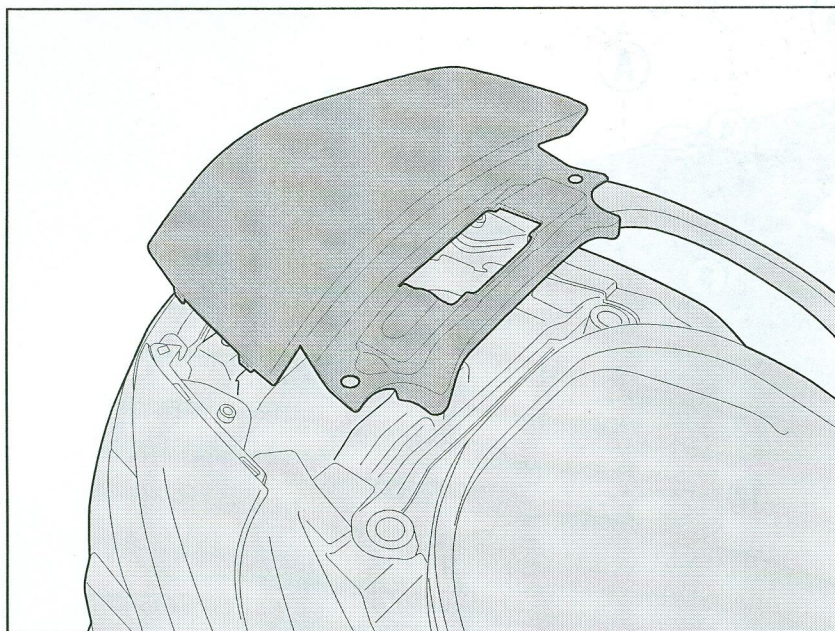

TOGLIERE

REMOVE

ENLEVER

ENTFERNEN

QUITAR

REMOVER



. FORARE NEI 3 PUNTI INDICATI; FORARE PRIMA CON UNA PUNTA PICCOLA ($\varnothing 6$), POI ALLARGARE I FORI ED ALL'OCCORRENZA CENTRARLI CON UNA PUNTA DA 16MM.

. PIERCE THE 3 POINTS MARKED; START WITH A SMALL POINT ($\varnothing 6$) AND CHECK THE POINTS ARE LINED UP WITH THE ORIGINAL SCREWS BELOW; THEN ENLARGE THE HOLES WITH A $\varnothing 6$ POINT.

. PERCER LES 3 POINTS INDICUES EN COMMENCANT AVEC UN FORET 6MM, VERIFIER QU'ILS SONT AQLIGNES AVEC LES VIS ORIGINALES DESSOUS, POIS AGGRANDIR LES TROUS AVEC UN FORET DE 16MM.

MIT EINEM 6MM BOHRER VORBOHREN; DANN UBERPRUFEN OB DIE BOHRUGEN MIT DEN ORIGINALSCHRAUBEN MITTING SIND; JETZT DIE LOCHER AUF 16MM AUFBOHREN.

. AGUJERAR EN LOS 3 PUNTOS INDICADOS; AGUJERAR PRIMERO CON LA PUNTA PEQUENA ($\varnothing 6$ MM), CONTROLAR QUE CONICIDAN CON LOS TORNILLOS QUE SE ENCUENTRAN EN EL CHASIS DE LA MOTO, LUEGO AMPLIAR EL AGUJERO CON UNA PUNTA DE 16MM.

. AGUJERAR EN LOS 3 PUNTOS INDICADOS; LUEGO EL AMPLIAR AGUJERO COM UM POUÇO DE 16 MILÍMETROS.

SR3104 - KR3104

PORTAPACCO SPECIFICO - SPECIFIC HOLDER - PORTE-PAQUET SPÉCIFIQUE - SPEZIFISCHER TRÄGER - PORTA-EQUIPAJE ESPECÍFICO - TRANSPORTADOR ESPECÍFICO

SUZUKI BURGMAN 650 (2013)

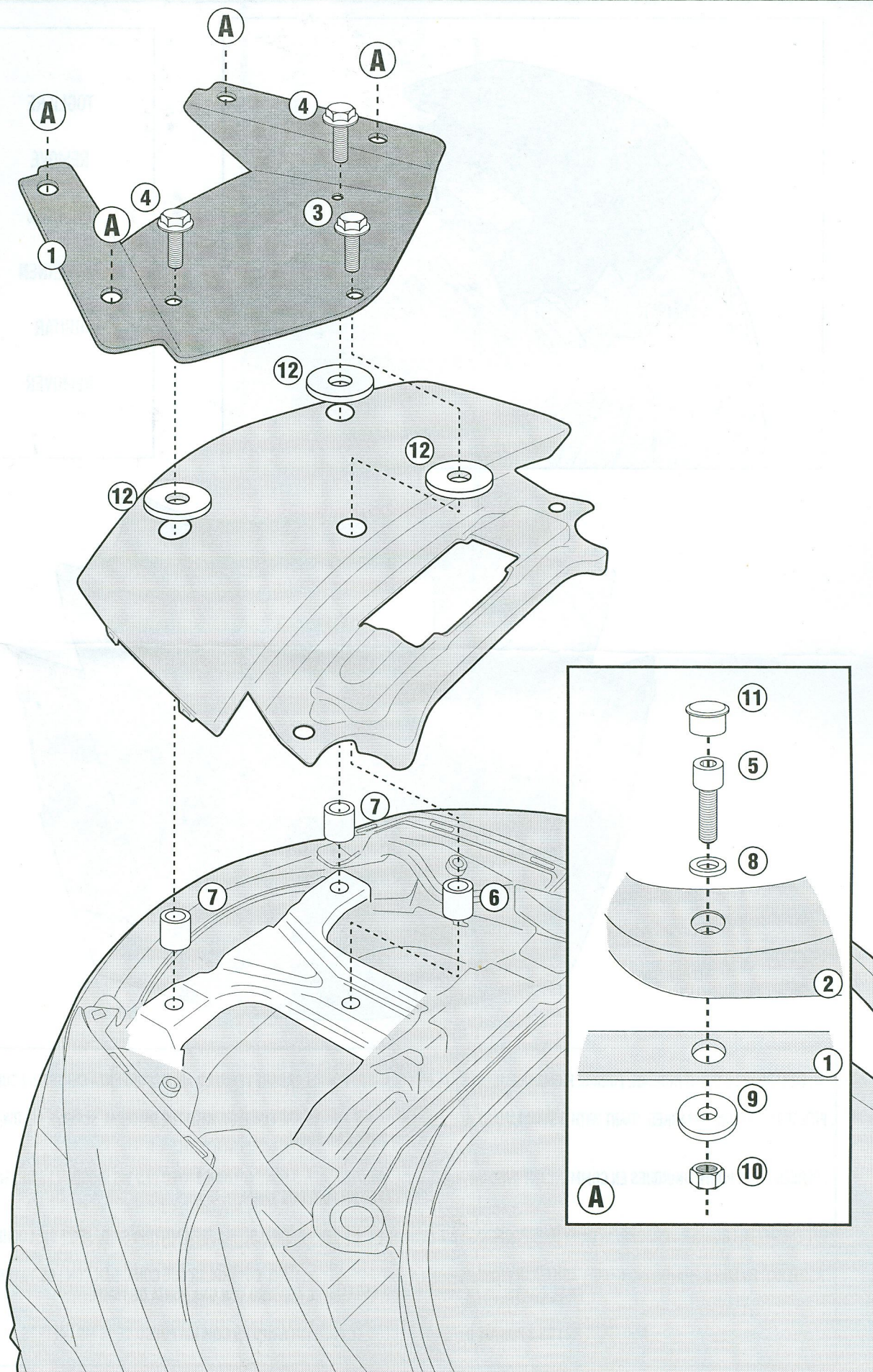

ISTRUZIONI DI MONTAGGIO - MOUNTING INSTRUCTIONS
INSTRUCTIONS DE MONTAGE - BAUANLEITUNG
INSTRUCCIONES DE MONTAJE - INSTRUÇÕES DE MONTAGEM