

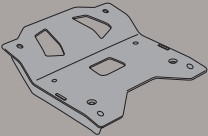

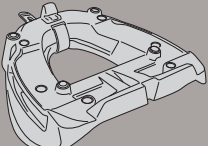







# SR4111MM - KR4111MM

PORTAPACCO SPECIFICO - SPECIFIC HOLDER - PORTE-PAQUET SPÉCIFIQUE - SPEZIFISCHER TRÄGER - PORTA-EQUIPAJE ESPECÍFICO - TRANSPORTADOR ESPECÍFICO

## KAWASAKI J300i (2014)

N°	Descrizione	Caratteristiche	Codice	Quantità	
1	Supporto - Support - Support Halierung - Soporte - Apoio	Sp. 3mm	GL2595	1	
2	Piastra - Plate Platine - Platte Parrilla - Grelha	-	M6M	1	
3	Vite - Screw Vis - Schraube Tornillo - Parafuso	TEF M6x50	650TECF	2	
4	Vite - Screw Vis - Schraube Tornillo - Parafuso	TEF M6x55	655TSP	2	
5	Vite - Screw Vis - Schraube Tornillo - Parafuso	TCEI M6x25	625TCE	4	
6	Distanziale - Spacer Entretoise - Distanzstueck Distanciador - Espaçador	Ø18x30 Foro 9,5mm	C18L30F9,5	2	
7	Distanziale - Spacer Entretoise - Distanzstueck Distanciador - Espaçador	Ø18x32 Foro 8,5mm	C18L32F8,5	2	
8	Rondella - Washer Rondelle - Scheibe Arandela - Arruela	Ø6	6RON	4	
9	Rondella - Washer Rondelle - Scheibe Arandela - Arruela	Ø6x18	618RON	4	
10	Dado - Bolt - Ecro Mutter - Tuerca - Porca	Auto Bloccante M6	6DADIAU	4	
11	Copriforo - Bolt Cap Cache Trou - Stopslock Tapa Agujero - Tampa do Orificio	-	Z621	6	

# SR4111MM - KR4111MM

PORTAPACCO SPECIFICO - SPECIFIC HOLDER - PORTE-PAQUET SPÉCIFIQUE - SPEZIFISCHER TRÄGER - PORTA-EQUIPAJE ESPECÍFICO - TRANSPORTADOR ESPECÍFICO

## KAWASAKI J300i (2014)

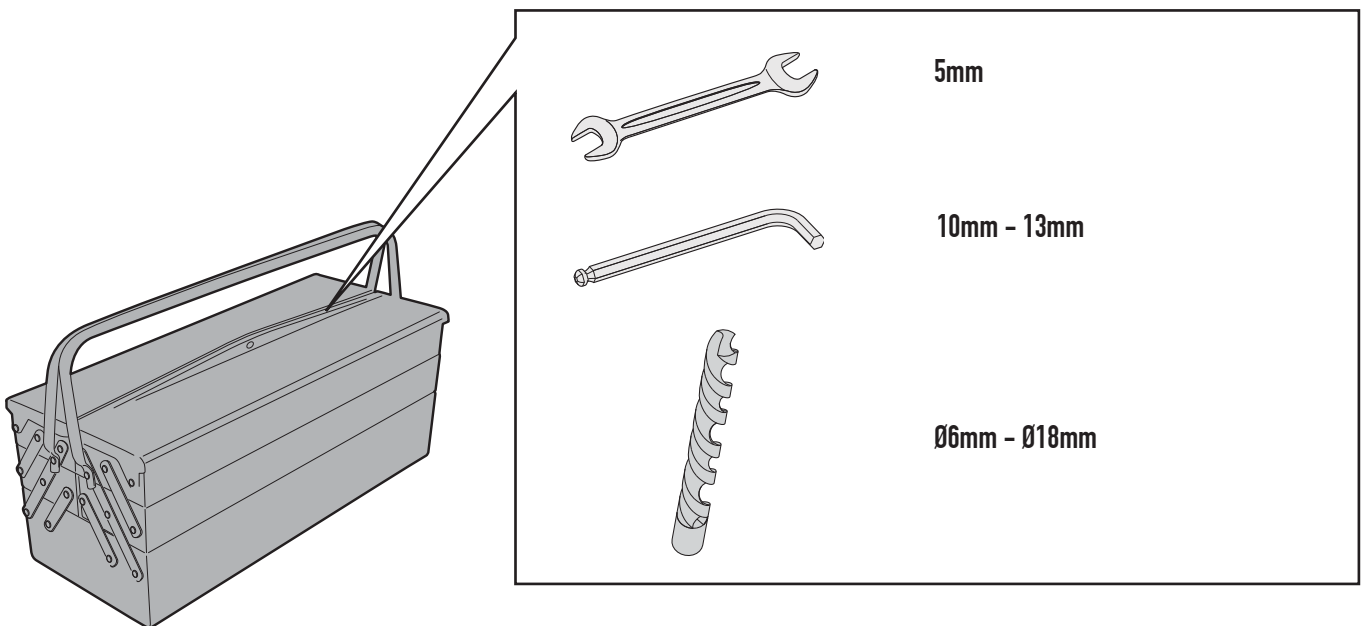

# SR411MM - KR411MM

PORTAPACCO SPECIFICO - SPECIFIC HOLDER - PORTE-PAQUET SPÉCIFIQUE - SPEZIFISCHER TRÄGER - PORTA-EQUIPAJE ESPECÍFICO - TRANSPORTADOR ESPECÍFICO

## KAWASAKI J300i (2014)

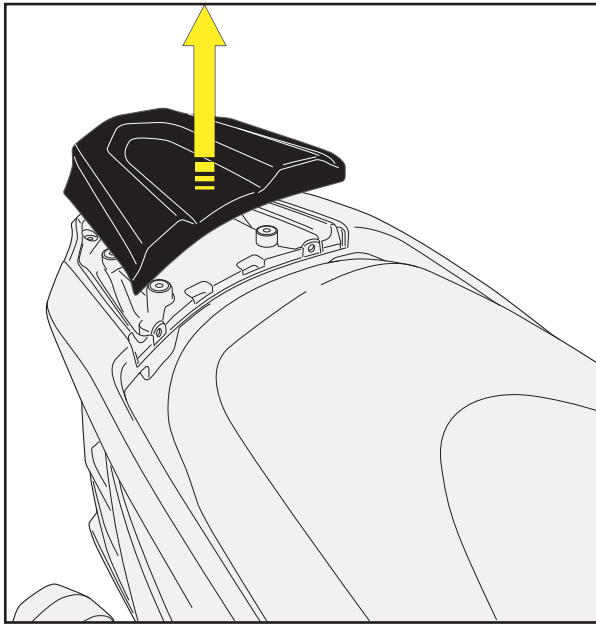

TOGLIERE

REMOVE

ENLEVER

ENTFERNEN

QUITAR

REMOVED

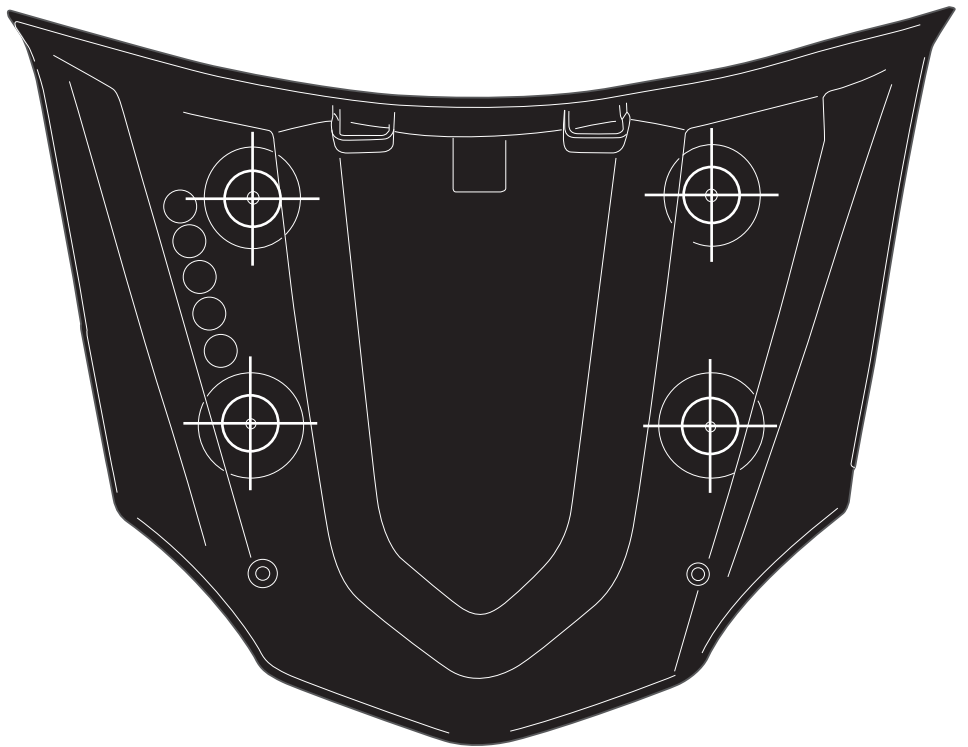
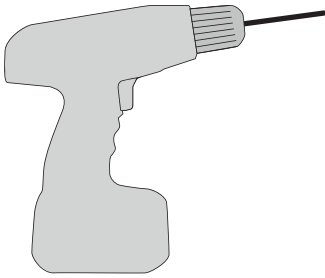

. FORARE NEI 4 PUNTI INDICATI; FORARE PRIMA CON UNA PUNTA PICCOLA (Ø6), POI ALLARGARLI CON UNA PUNTA DA 18MM.

. PIERCE THE 4 POINTS MARKED; START WITH A SMALL POINT (Ø6) AND CHECK THE POINTS ARE LINED UP WITH THE ORIGINAL SCREWS BELOW; THEN ENLARGE THE HOLES WITH A Ø18 POINT.

. PERCER LES 4 POINTS INDIQUE EN COMMENCANT AVEC UN FORET 6MM, VERIFIER QU'ILS SONT A LIGNE AVEC LES VIS ORIGINALES DESSOUS, POIS AGGRANDIR LES TROUS AVEC UN FORET DE 18MM.

MIT EINEM 6MM BOHRER VORBOHREN; DANN ÜBERPRÜFEN OB DIE BOHRUGEN MIT DEN ORIGINALSCHRAUBEN MITTING SIND; JETZT DIE LOCHER AUF 18MM AUFBOHREN.

. AGUJERAR EN LOS 4 PUNTOS INDICADOS; AGUJERAR PRIMERO CON LA PUNTA PEQUENA (Ø6MM), CONTROLAR QUE CONICIDAN CON LOS TORNILLOS QUE SE ENCUENTRAN EN EL CHASIS DE LA MOTO, LUEGO AMPLIAR EL AGUJERO CON UNA PUNTA DE 18MM.

. AGUJERAR EN LOS 4 PUNTOS INDICADOS; LUEGO EL AMPLIAR AGUJERO CON UN POCO DE 18 MILÍMETROS.

ISTRUZIONI DI MONTAGGIO - MOUNTING INSTRUCTIONS  
INSTRUCTIONS DE MONTAGE - BAUANLEITUNG  
INSTRUCCIONES DE MONTAJE - INSTRUÇÕES DE MONTAGEM

# SR4111MM - KR4111MM

PORTAPACCO SPECIFICO - SPECIFIC HOLDER - PORTE-PAQUET SPECIFIQUE - SPEZIFISCHER TRÄGER - PORTA-EQUIPAJE ESPECÍFICO - TRANSPORTADOR ESPECÍFICO

## KAWASAKI J300i (2014)

