

GPT.05.285.100



SUZUKI GS 500 E/F

Alu-Rack Montagehinweise

Alle vom Motorrad gelösten Schrauben sind gemäß Herstellerangaben wieder zu montieren, oder mit von SW-MOTECH gelieferten Schrauben zu ersetzen. Falls nicht anderweitig definiert, diese Schrauben nach Tabelle anziehen.

M6	9,6 Nm
M8	23 Nm
M10	46 Nm

Gegebenenfalls Schrauben mit flüssiger Schraubensicherung einkleben.

Prüfen Sie nach 50 km alle Verbindungen auf festen Sitz.

Maximale Zuladung der Koffer :
Gemäß Herstellerangaben

SW-MOTECH GmbH & Co. KG
Bahnhofstrasse 44d
35282 Rauschenberg
-Germany-

Tel.: ++ 49 (0) 6425 820 280

Fax: ++ 49 (0) 6425 820 281

www.sw-motech.com

Alu-Rack Mounting Instructions





SW-MOTECH products should be installed by a qualified, experienced motorcycle technician. If you are unsure of your ability to properly install a product, please have the product installed by your local motorcycle dealer. SW-MOTECH takes no responsibility for damages caused by improper installation.

All screws, bolts and nuts, including all replacement hardware provided by SW-MOTECH, should be tightened to the torque specified in the OEM maintenance manual for your motorcycle. If no torque specifications are provided in the OEM maintenance manual, the following torques may be used:

M6	9,6 Nm
M8	23 Nm
M10	46 Nm

All screws, bolts and nuts should be checked after driving the first 50 km to ensure that all are tightened to the proper torque.

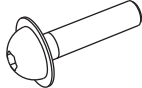
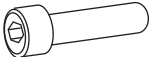
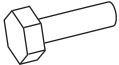
Medium strength liquid thread-locker (i.e., "Loctite") should be used to secure all screws, bolts, and nuts.

<p>1 Alu-Rack Alu-Rack</p>  <p>GPT.06.240.001</p> <p>Anzahl/ Pcs. 1</p>	<p>5 Traverse Middle Bracket</p>  <p>GPT.05.285.002</p> <p>Anzahl/ Pcs. 1</p>
<p>2 Unterbau Bottom Bracket</p>  <p>GPT.05.285.001</p> <p>Anzahl/ Pcs. 1</p>	<p>6 Linsenkopfschrauben mit Innensechskant Lenshead Screw</p>  <p>M8 x 20 ISO 7380</p> <p>Anzahl/ Pcs. 4</p>
<p>3 Zylinderschraube mit Innensechskant Hexagon Socket Screw</p>  <p>M8 x 20 DIN 912</p> <p>Anzahl/ Pcs. 2</p>	<p>7 Sechskantschraube Hexagon Screw</p>  <p>M 8 x 20 DIN 931</p> <p>Anzahl/ Pcs. 2</p>
<p>4 Unterlegscheibe Washer</p>  <p>A 8,4 DIN 125</p> <p>Anzahl/ Pcs. 4</p>	<p>8 Mutter mit Bund, selbstsichernd Lock Nut</p>  <p>M 8 DIN 6927</p> <p>Anzahl/ Pcs. 2</p>



SW-MOTEC
engineering for motorbikes

GPT.05.340.100

I

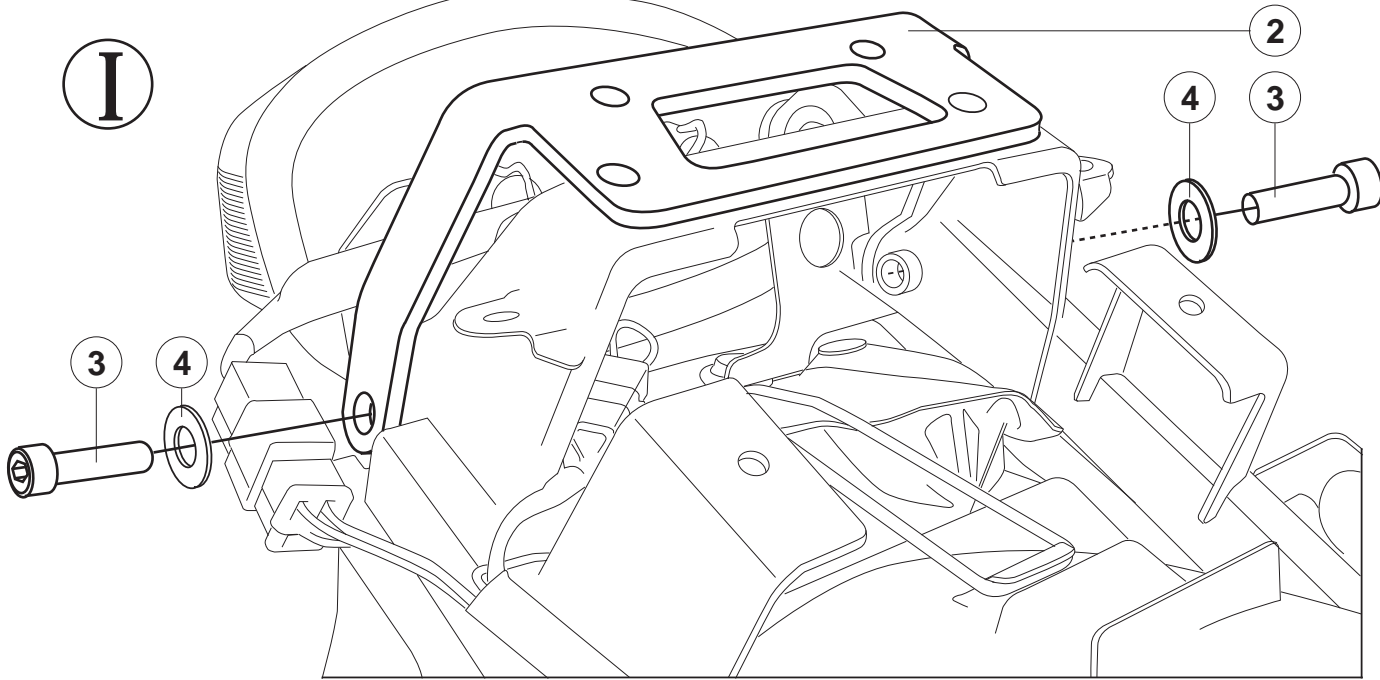

II

! Original Schrauben verwenden.
Use original screws.

