



## YAMAHA MT03

### Schutzbügel Montagehinweise

Alle vom Motorrad gelösten Schrauben sind gemäß Herstellerangaben wieder zu montieren, oder mit von SW-MOTECH gelieferten Schrauben zu ersetzen. Falls nicht anderweitig definiert, diese Schrauben nach Tabelle anziehen.

M6	9,6 Nm
M8	23 Nm
M10	46 Nm

Gegebenenfalls Schrauben mit flüssiger Schraubensicherung einkleben.

Prüfen Sie nach 50 km alle Verbindungen auf festen Sitz.

SW-MOTECH GmbH & Co. KG  
Bahnhofstrasse 44d  
35282 Rauschenberg  
-Germany-

Tel.: ++ 49 (0) 6425 816 800

Fax: ++ 49 (0) 6425 816 810

[www.sw-motech.com](http://www.sw-motech.com)

### Crash Bar Mounting Instructions

SW-MOTECH products should be installed by a qualified, experienced motorcycle technician. If you are unsure of your ability to properly install a product, please have the product installed by your local motorcycle dealer. SW-MOTECH takes no responsibility for damages caused by improper installation.

All screws, bolts and nuts, including all replacement hardware provided by SW-MOTECH, should be tightened to the torque specified in the OEM maintenance manual for your motorcycle. If no torque specifications are provided in the OEM maintenance manual, the following torques may be used:

M6	9,6 Nm
M8	23 Nm
M10	46 Nm

All screws, bolts and nuts should be checked after driving the first 50 km to ensure that all are tightened to the proper torque.

Medium strength liquid thread-locker (i.e., "Loctite") should be used to secure all screws, bolts and nuts.

! Auf der rechten Seite mit Distanzbuchse (13) und Mutter (14) verschrauben.

Use spacer (13) and nut (14) on the right side.

**A**

4  
9

**B**

**C**

linke Seite / left side

3 2 1 7 6

Anbaupunkte linke Seite / Fixing points left side

**A**

**B**

Wenn der original Zubehör-Motorschutz verwendet werden soll, ersetzen Sie Innensechskantschraube (6) und Distanzbuchse (9) durch Innensechskantschraube (5) und Distanzbuchse (8).

If you will use the original skit splate, use screw (5) and spacer (8).

**C**

Wenn der SW-MOTECH Hauptständer (Art.-Nr.: HPS.06.545.100) verwendet werden soll, entfällt Distanzbuche (12).

If you will use the SW-MOTECH centre stand, you doesn't need spacer (12).

11 10

12

! Auf der rechten Seite mit Distanzbuchse (25) und Mutter (24) verschrauben.

Use spacer (25) and nut (24) on the right side.

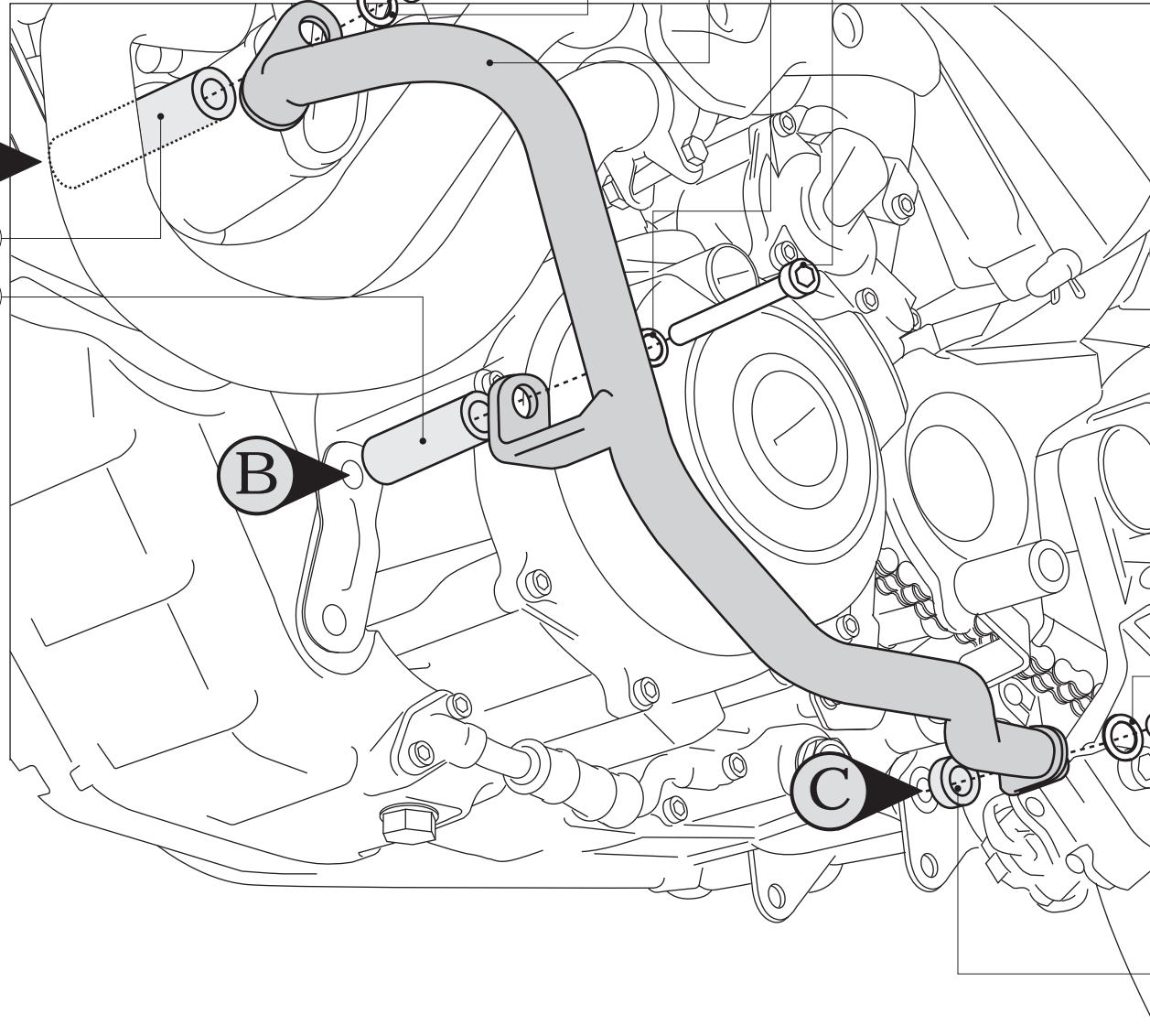

1 Schutzbügel  
Crash Bar

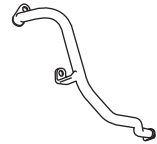

SBL.06.547.901/902 (L/R)

Anzahl/ Pcs. 2 (L/R)

2 Innensechskantschraube  
Hexagon Socket Screw

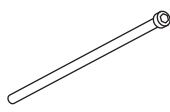

M10 x 260 DIN 912

Anzahl/ Pcs. 1

5 Innensechskantschraube  
Hexagon Socket Screw

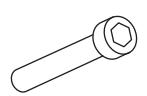

M8 x 50 DIN 912

Anzahl/ Pcs. 1

9 Distanzbuchse  
Spacer

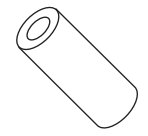

Da:18 Di:8,4 h:52

Anzahl/ Pcs. 1

10 Innensechskantschraube  
Hexagon Socket Screw



M10 x 190 DIN 912

Anzahl/ Pcs. 1

3 Unterlegscheibe  
Washer



A: 10,5 DIN 125

Anzahl/ Pcs. 1

6 Innensechskantschraube  
Hexagon Socket Screw

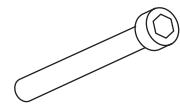

M8 x 70 DIN 912

Anzahl/ Pcs. 1

11 Unterlegscheibe  
Washer

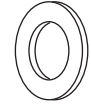

A: 10,5 DIN 125

Anzahl/ Pcs. 1

4 Distanzbuchse  
Spacer

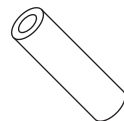

Da:20 Di:10,5 h:70

Anzahl/ Pcs. 1

7 Unterlegscheibe  
Washer



A: 8,4 DIN 125

Anzahl/ Pcs. 1

12 Distanzbuchse  
Spacer

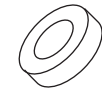

Da:20 Di:10,5 h:8

Anzahl/ Pcs. 1

8 Distanzbuchse  
Spacer

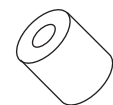

Da:25 Di:8,4 h:25

Anzahl/ Pcs. 1

Anbauapunkt B, rechte Seite  
 Fixing Point B, right side

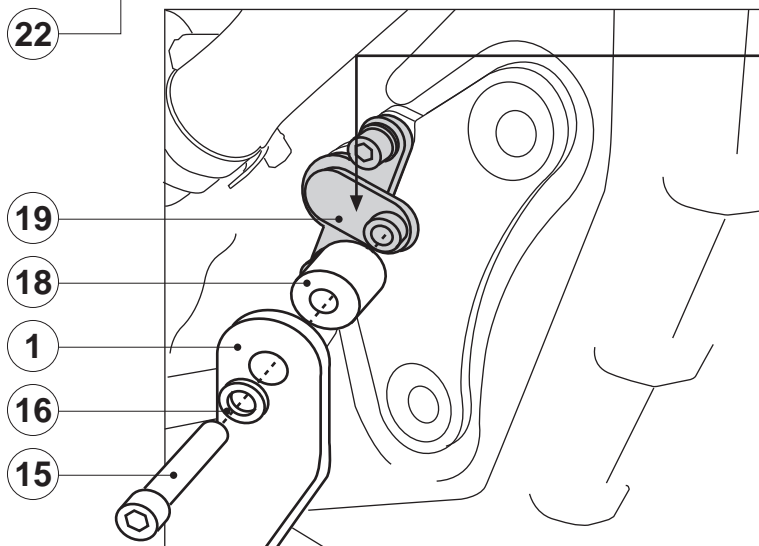
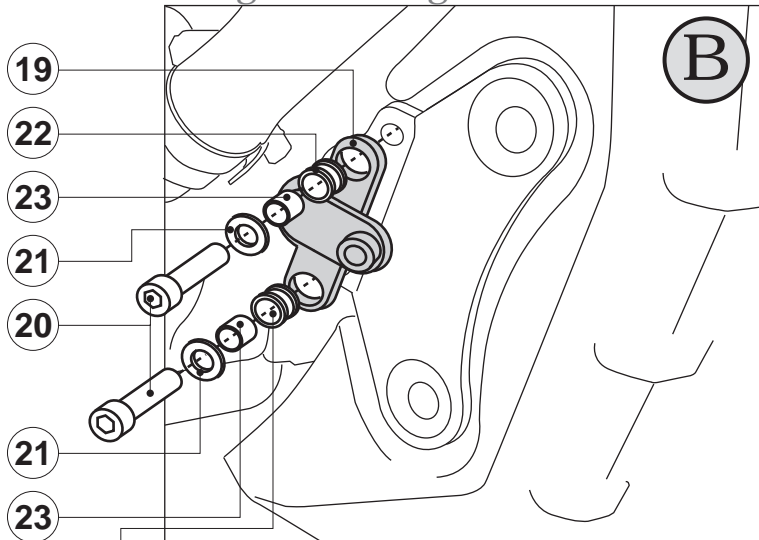

Anbauapunkte rechte Seite / Fixing points right side

**A** -

**B** Wenn der original Zubehör-Motorschutz verwendet werden soll, ersetzen Sie Distanzbuchse (18) durch Distanzbuchse (17).  
 If you will use the original skit splate, use spacer (17).

**C** Wenn der SW-MOTECH Hauptständer (Art.-Nr.: HPS.06.545.100) verwendet werden soll, ersetzen Sie Distanzbuchse (25) durch Distanzbuchse (26).  
 If you will use the SW-MOTECH centre stand, use spacer (25) to mount the crash bar (26).

**!** Anbautraverse (19) sollte auch bei Montage des original Zubehör-Motorschutzes benutzt werden.  
 You can use fixing bracket (19) if you will use the original skit-plate.

13 Distanzbuchse  
Spacer

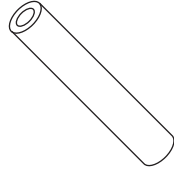

Da:20 Di:10,5 h:100

Anzahl/ Pcs. 1

15 Innensechskantschraube  
Hexagon Socket Screw

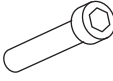

M8 x 40 DIN 912

Anzahl/ Pcs. 1

19 Befestigungstraverse  
Fixing Bracket



SBL.06.547.922

Anzahl/ Pcs. 1

23 Distanzbuchse  
Spacer



Da:8 Di:6,2 h:10

Anzahl/ Pcs. 2

24 Mutter mit Bund,  
selbstsichend  
Lock Nut



M10 DIN 6927

Anzahl/ Pcs. 1

14 Mutter mit Bund,  
selbstsichernd  
Lock Nut



M10 DIN 6927

Anzahl/ Pcs. 1

16 Unterlegscheibe  
Washer



A: 8,4 DIN 125

Anzahl/ Pcs. 1

20 Innensechskantschraube  
Hexagon Socket Screw



M6 x 25 DIN 912

Anzahl/ Pcs. 2

25 Distanzbuchse  
Spacer



Da:20 Di:10,5 h:50

Anzahl/ Pcs. 1

17 Distanzbuchse  
Spacer



Da:25 Di:8,4 h:15

Anzahl/ Pcs. 1

21 Unterlegscheibe  
Washer



A: 6,4 DIN 9021

Anzahl/ Pcs. 2

26 Distanzbuchse  
Spacer



Da:20 Di:10,5 h:42

Anzahl/ Pcs. 2

18 Distanzbuchse  
Spacer



Da:18 Di:8,4 h:22

Anzahl/ Pcs. 1

22 Gummitülle  
Rubber Element



GT.00.12H3476

Anzahl/ Pcs. 2