

MSS.06.371.100

Revision: 01



YAMAHA XT 660

Motorschutz Montagehinweise

Alle vom Motorrad gelösten Schrauben sind gemäß Herstellerangaben wieder zu montieren, oder mit von SW-MOTECH gelieferten Schrauben zu ersetzen. Falls nicht anderweitig definiert, diese Schrauben nach Tabelle anziehen.

M6	9,6 Nm
M8	23 Nm
M10	46 Nm

Gegebenenfalls Schrauben mit flüssiger Schraubensicherung einkleben.

Prüfen Sie nach 50 km alle Verbindungen auf festen Sitz.

SW-MOTECH GmbH & Co. KG
Bahnhofstrasse 44d
35282 Rauschenberg
-Germany-

Tel.: ++ 49 (0) 6425 816 800
Fax: ++ 49 (0) 6425 816 810

www.sw-motech.com

Skid plate Mounting Instructions











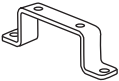

SW-MOTECH products should be installed by a qualified, experienced motorcycle technician. If you are unsure of your ability to properly install a product, please have the product installed by your local motorcycle dealer. SW-MOTECH takes no responsibility for damages caused by improper installation.

All screws, bolts and nuts, including all replacement hardware provided by SW-MOTECH, should be tightened to the torque specified in the OEM maintenance manual for your motorcycle. If no torque specifications are provided in the OEM maintenance manual, the following torques may be used:

M6	9,6 Nm
M8	23 Nm
M10	46 Nm

All screws, bolts and nuts should be checked after driving the first 50 km to ensure that all are tightened to the proper torque.

Medium strength liquid thread-locker (i.e., "Loctite") should be used to secure all screws, bolts and nuts.

<p>1 Sechskantschraube Hexagon Screw</p>  <p>M10 x 170 DIN 931</p> <p>Anzahl/ Pcs. 1</p>	<p>5 Anbautraverse vorne Front Mounting Bracket</p>  <p>MSS.06.371.002</p> <p>Anzahl/ Pcs. 1</p>	<p>9 Anbautraverse hinten Rear Mounting Bracket</p>  <p>MSS.06.371.003</p> <p>Anzahl/ Pcs. 1</p>
<p>2 Unterlegscheibe Washer</p>  <p>A 10,5 DIN 125</p> <p>Anzahl/ Pcs. 1</p>	<p>6 Sechskantschraube Hexagon Screw</p>  <p>M6 x 16 DIN 933</p> <p>Anzahl/ Pcs. 2</p>	<p>10 Sechskantschraube Hexagon Screw</p>  <p>M8 x 16 DIN 933</p> <p>Anzahl/ Pcs. 2</p>
<p>3 Distanzbuchsen Spacer</p>  <p>Da:20 Di:10,5 h:32</p> <p>Anzahl/ Pcs. 2</p>	<p>7 Unterlegscheibe Washer</p>  <p>A 6,4 DIN 9021</p> <p>Anzahl/ Pcs. 2</p>	<p>11 Unterlegscheibe Washer</p>  <p>A 8,4 DIN 9021</p> <p>Anzahl/ Pcs. 2</p>
<p>4 Distanzbuchsen Spacer</p>  <p>Da:20 Di:10,5 h:9</p> <p>Anzahl/ Pcs. 2</p>	<p>8 Mutter mit Bund Lock Nut</p>  <p>M 10 DIN 6927</p> <p>Anzahl/ Pcs. 1</p>	<p>12 Motorschutz Skid Plate</p>  <p>MSS.06.371.900</p> <p>Anzahl/ Pcs. 1</p>

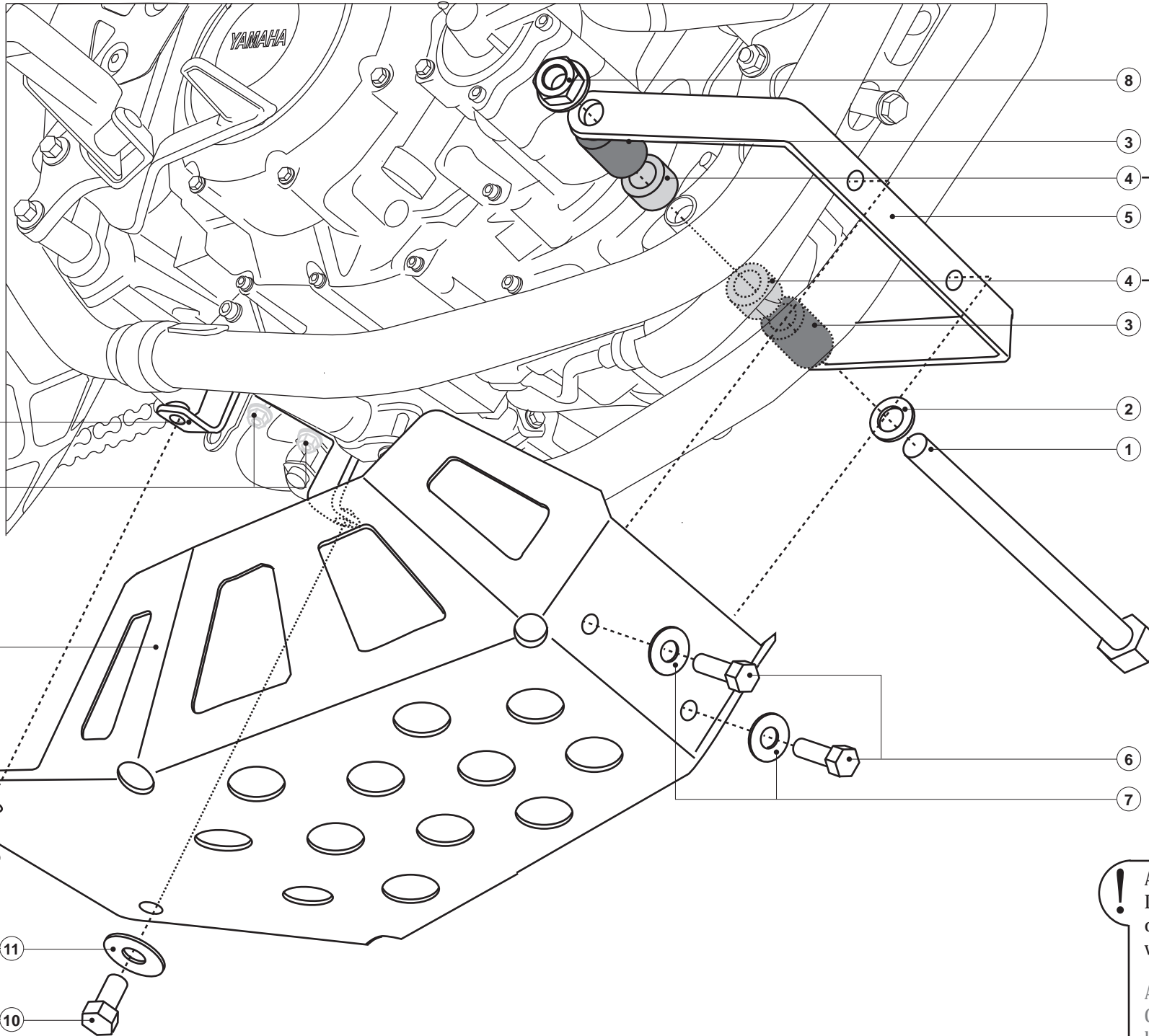

Original
 Schraube/Mutter
 Original Screw/Nut

! Achtung:
 Die Distanzbuchsen (4) entfallen,
 wenn der Motorschutz
 zusammen mit dem SW-MOTECH
 Schutzbügel (SBL.06.283.100)
 montiert wird.

Attention:
 If you attache the skid-plate
 together with the SW-MOTECH
 crash bar (SBL.06.283.100),
 you doesn't need the spacer (4).

! Achtung:
 Die Kurven- und Bodenfreiheit kann
 durch einen Motorschutz eingeschränkt
 werden.

Attention:
 Cornering and ground clearance can
 be reduced by using a skid plate.