

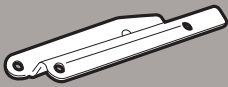





SR1153 - KR1153

PORTAPACCO SPECIFICO - SPECIFIC HOLDER - PORTE-PAQUET SPÉCIFIQUE - SPEZIFISCHER TRÄGER - PORTA-EQUIPAJE ESPECÍFICO

HONDA VISION 50-110 (2017)

N°	Descrizione	Caratteristiche	Codice	Quantità	
1	Supporto - Support - Support Halterung - Soporte	-	-	2 (Dx,Sx)	
2	Vite - Screw Vis - Schraube Tornillo	TBEI M6x25mm	-	4	
3	Vite - Screw Vis - Schraube Tornillo	TEF M6x20	-	4	
4	Rondella - Washer Rondelle - Scheibe Arandela	Ø6	-	8	
5	Dado - Bolt - Ecrou Mutter - Tuerca	Auto Bloccante Flangiato M6	-	4	
6	Dado - Bolt - Ecrou Mutter - Tuerca	Auto Bloccante Ribas- sato M6	-	4	
7	Particolari inclusi nel kit viteria della piastra Components included in the fitting kit of the plate Pièces incluses dans le kit de vis de la platine Die einzelnen teile sind bei montagekit der platte enthalten Despieces incluidos en el kit de anclajes de la parrilla	-	-	-	-
8	Rondella - Washer Rondelle - Scheibe Arandela	Rondella in gomma	-	4	

SR1153 - KR1153

PORTAPACCO SPECIFICO - SPECIFIC HOLDER - PORTE-PAQUET SPÉCIFIQUE - SPEZIFISCHER TRÄGER - PORTA-EQUIPAJE ESPECÍFICO

HONDA VISION 50-110 (2017)

ATTENZIONE: Carico Massimo 3Kg.

WARNING: Max Load, 3Kg.

ATTENTION: Charge Maximum, 3Kg.

ACHTUNG: Max, 3Kg.

¡ATENCIÓN!: Carga Máxima, 3Kg.

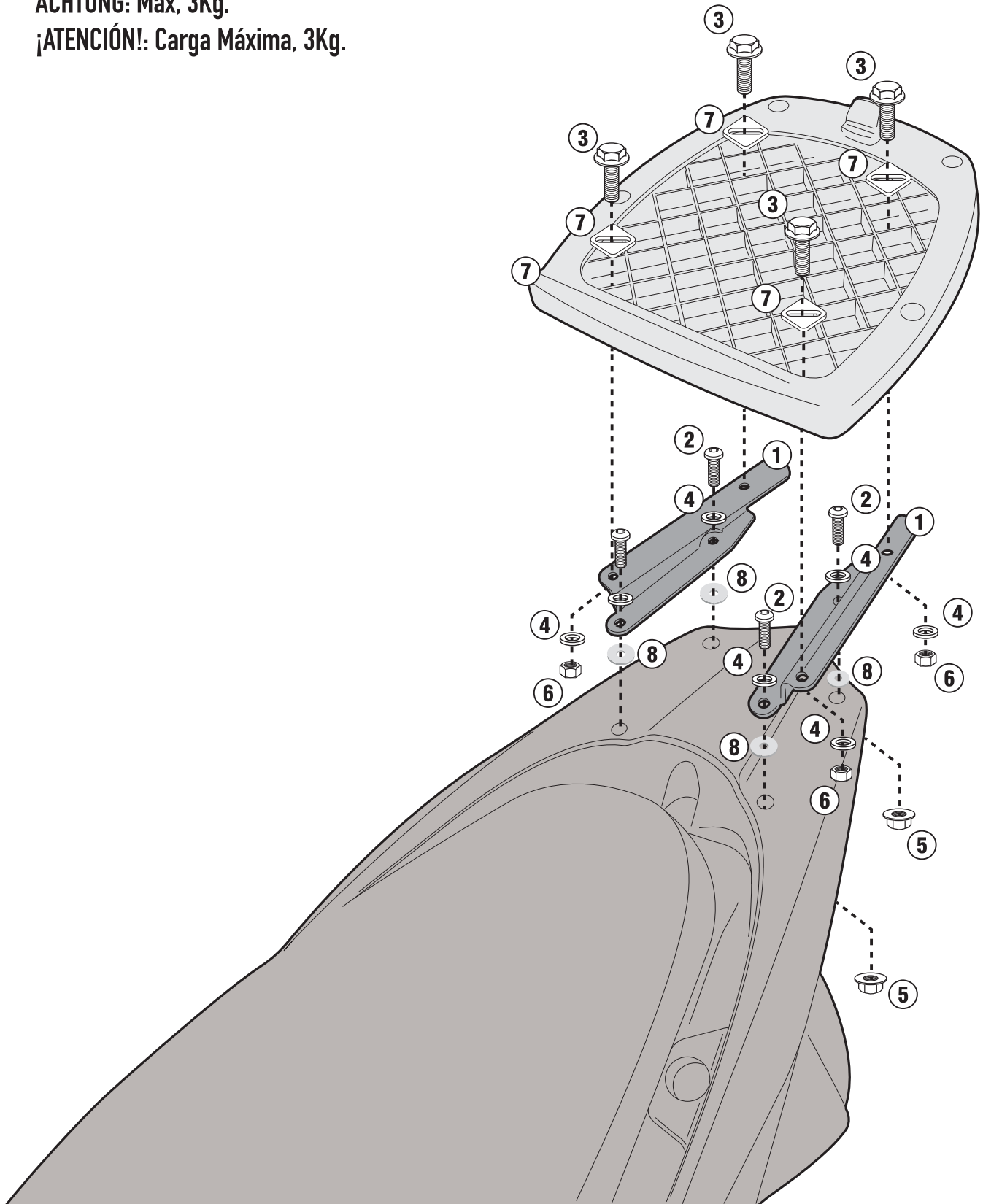

ISTRUZIONI DI MONTAGGIO - MOUNTING INSTRUCTIONS
INSTRUCTIONS DE MONTAGE - BAUANLEITUNG - INSTRUCCIONES
DE MONTAJE